

Thinking of you

 **Electrolux**

Electrolux Professional
Tumble Dryers





Electrolux invented Natural Drying

Follow the **wave**.



A woman with blonde hair, wearing a light-colored blazer over a white shirt, is seated in a private jet cabin. She is looking out the window with a thoughtful expression, her hand resting near her chin. The cabin interior is visible, including a wooden console with a control panel and a cup holder.

Care and excellence

Excellence is part of our philosophy:
in planning, technology, design and service.

Smart solutions just for you

Flexibility and design mean Electrolux machines can be adapted to suit every type of laundry, whatever your needs.



Hospitality

Pristine linen and the highest standard of hygiene make all the difference to your customer's satisfaction.

Healthcare

The most demanding hygiene standards in nursing homes and children's day nurseries are met with Electrolux dryers.



Laundrettes

Perfect results wash after wash with energy-efficient, low-maintenance machines.

Apartment House Laundries

Low noise emissions and excellent drying performance make Electrolux machines the ideal choice for residential buildings.



Dry Cleaners

The Electrolux Lagoon™ system is the only wet-cleaning process in the world for delicate garments approved by The Woolmark Company.

Commercial Laundries

Commercial laundries need to be competitive. That is why our large industrial machines are designed to deliver you excellent results with high energy and cost efficiency.

A photograph of a sailboat on the water during sunset. The sun is low on the horizon, creating a golden glow over the water and the sails. The text "A gentle breeze dries efficiently" is overlaid in white on the left side of the image.

A gentle breeze
dries efficiently

Exceptionally high performance combined with cost efficiency

Obtain great results and improve your laundry's efficiency by minimising running costs with Electrolux tumble dryers.

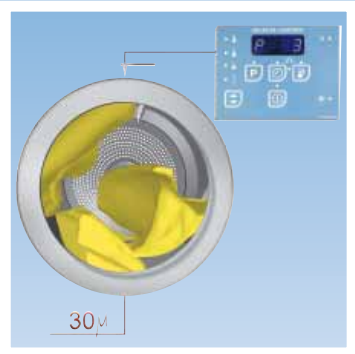
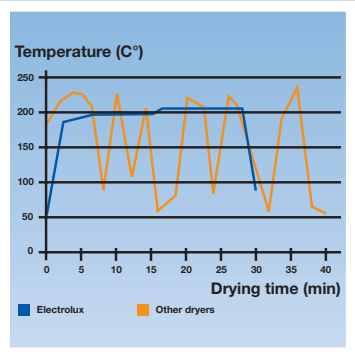

Accurate temperature control
Extensive laboratory tests show that Electrolux tumble dryers provide shorter and more efficient drying cycles thanks to their accurate temperature control.

Residual Moisture Control
RMC measures the exact moisture content in the linen and automatically helps you to save time, energy and money. It is a must for delicate fabrics like wool and silk.



Advanced blower wheel
With our new generation blower wheels it is possible to optimise airflow and minimise maintenance costs.

Reverse drum action
The counter-clockwise drum rotation prevents linen from tangling and wrinkling, thus making finishing easier and improving drying efficiency.



Certus Management Information System™ (CMIS)
Innovative software from Electrolux that allows you to connect machines to a network to monitor all operating costs and program & consumption data - validating every processed batch.

Safety & Standards
Electrolux tumble dryers comply with all International safety standards and product quality specifications for your complete peace of mind.

Designed with you in mind

Ergonomic design and specific incorporated features ensure that Electrolux dryers are simple and safe to use.



Drum speed control

Thanks to our adjustable drum speed - excellent results are guaranteed, even with the most delicate loads.

Sliding doors

No more uncomfortable loading and unloading in critical locations. With our sliding doors, you no longer need a large amount of space for an efficient laundry flow.

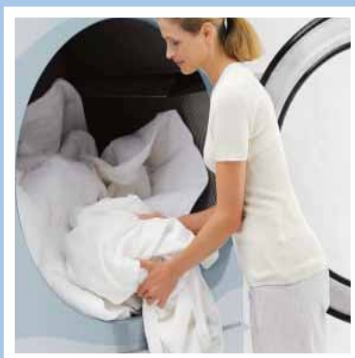

Forward tilting

The forward tilting and simultaneous rotation of the drum makes manual handling unnecessary. This results in excellent hygiene standards and improved working conditions for operators.

Door

The large diameter of the opening ensures easy loading and unloading. The door opens to nearly 180° and can be hinged to the left or right for optimal laundry flow.

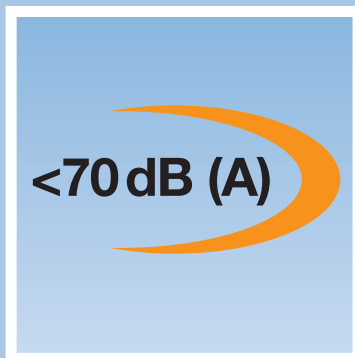

Lint filter

Maintenance is minimised thanks to the large lint filter. Lint can easily be removed from the bottom of the compartment.

Low noise

Everyone seeks a quiet working environment. Electrolux tumble dryers are designed to keep the noise level below 70 dB (A).

Excellence in every detail

Electrolux tumble dryers are designed for quick and simple installation. Only one external connection for electricity, gas and exhaust is required.

Customised controls and user panels

Sturdy drum suspension with double sealed bearings and belt drive

Improved access to vital parts to make servicing easy

Advanced blower wheel less sensitive to lint accumulation and pressure drop

Large self-cleaning lint screen and large lint compartment for easy maintenance

Galvanised panels and powder painted exterior to protect against rust and corrosion

Support rollers for increased drum stability and noise reduction

Large door opening for easy loading and unloading



Electrolux
technology
makes life
easier

Designed to have everything under control

Complete control over the drying process is possible thanks to our advanced microprocessor technology. With our Compass and Selecta controls it is simple to choose alternative settings for maximum drying flexibility.

Compass Control®



- Compass Control®**
- Multilingual
 - Larger display
 - Quick start buttons
 - Multi-programmable

Quick start

Our quick start options allow you to preset 2 of your most frequently used programs.

Easy reading

Text makes program identification easy.

Search ease

The ergonomic knob ensures quick and easy program selection.

Selecta Coin



Selecta Coin

- Temperature selection
- Drying time determined by payment system
- Display shows remaining drying time

Selecta AHL



Selecta Apartment House Laundry

- Temperature, program and time selection
- Display shows selected program, remaining drying time, cool-down time, actual temperature and moisture content (with RMC)
- Fully programmable

Selecta OPL



Selecta On Premises Laundry

- Temperature, program, time, reversing and cool-down selection
- Display shows selected program, remaining drying time, cool-down time, actual temperature and moisture content (with RMC)
- Fully programmable

The best care
always



Truly tailor-made

Tumble dryers can be customised with a wide range of options and accessories to give you the perfect machine.
All tumble dryers can be customised with a wide range of options and accessories to give you the machine you really want.

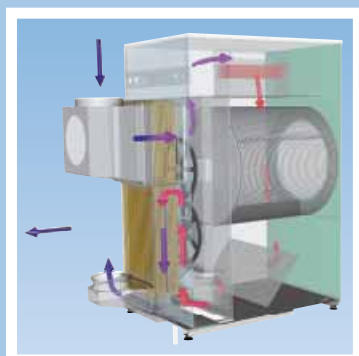

Heat recovery pipes and heat exchangers

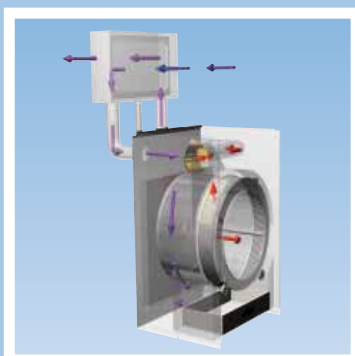

Condensing unit

Heat recovery pipes and heat exchangers

Exchangers save up to 25% of the total energy consumption due to our optimised exchange principle.

Condensing unit

A special condensing unit removes humidity from the exhaust air. This is the best solution when an external connection is not possible.

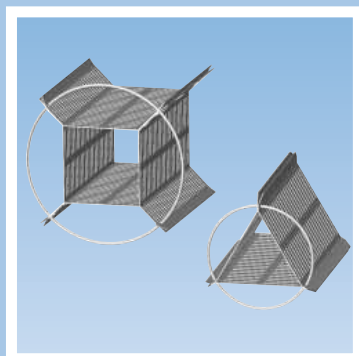

Special equipment insert

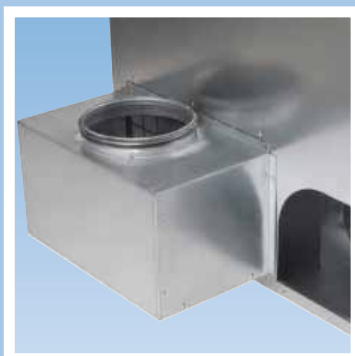

Fresh air intake

Special equipment insert

Using our dedicated insert allows you to avoid damage and scratching to special and delicate items (e.g. Protection masks for fire brigade.)

Fresh air intake

The fresh air intake provides optimum air conditions while reducing energy consumption and drying times.



Electrolux Service

- Maintain equipment in prime condition
- Prevent costly and untimely break-downs
- Reduce stress and unexpected problems
- Retain the value of your investment for many years to come
- Reduce overall operating costs
- Fully qualified and trained Electrolux certified engineers

Tailor your choice

Legend

● Standard ○ Option - Not available



| Model | | T4130 | T4190 | T4250 | |
|-----------------------|-------------------------|---|-----------|----------|--------|
| Comments | | | | | |
| Capacity | Drum volume in litres | 130 | 190 | 250 | |
| | Dry weight capacity kg | Filling factor 1:18 | 7.2 | 10.6 | 13.9 |
| | Dry weight capacity kg | Filling factor 1:25 | 5.2 | 7.6 | 10 |
| | Dry weight capacity lb | Filling factor 1:18 | 16 | 23 | 31 |
| | Dry weight capacity lb | Filling factor 1:25 | 11 | 17 | 22 |
| Dimensions | Width (mm) | 595 | 720 | 790 | |
| | Depth (mm) | 700 | 725 | 900 | |
| | Height (mm) | 850 | 1113 | 1740 | |
| | Width (in) | 23-6/16" | 28-5/16" | 31-2/16" | |
| | Depth (in) | 27-10/16" | 28-8/16" | 35-6/16" | |
| | Height (in) | 33-8/16" | 43-13/16" | 68-8/16" | |
| Heating | Electric | ● | ○ | ○ | |
| | Gas | - | ○ | ○ | |
| | Steam | - | - | ○ | |
| Consumption* | Heat | kW rating of electric or gas heating | 5.1 | 8 | 13.5 |
| | Energy | kW per load/kg | 2.7/5.5 | 3.5/7.6 | 5.8/11 |
| | Time | Minutes per load (excl. cool down)/Kg | 34/5.5 | 27/7.6 | 27/11 |
| Front Panel | Painted | ● | ● | ● | |
| | Stainless Steel | ○ | ○ | ○ | |
| Drum | Galvanised | - | ● | ● | |
| | Stainless Steel | ● | ○ | ○ | |
| Controls | Compass Control® | ● | ● | - | |
| | Selecta Control® | - | - | ● | |
| Control option | Autostop | Not available with coin machines | - | ● | ● |
| | RMC | Not available with coin machines | ● | ○ | ○ |
| Payment | Coin meter | ○ | ○ | ○ | |
| | Central / single system | ○ | ○ | ○ | |
| Drum | Reversing drum | Only with 3 phase supply, T4130 and T4190 | ● | ○ | ○ |
| | Speed control | | - | - | - |
| Power supply | 3 phase | ○ | ● | ● | |
| | Single phase | For gas, steam, T4130 and T4190 | ● | ○ | ○ |
| Loading system | Sliding door | - | - | - | |
| | Forward tilting | - | - | - | |
| Heat recovery | Pipes | - | - | - | |
| | Condensing | ○ | ○ | - | |

* Consumption data is for mentioned electric or gas heating at a specific test load of 100% cotton dried from 50% to 0% moisture

Share more of our thinking at www.electrolux.com

Environment

Being environmentally friendly is more than just a concern to us. It means being truly conscious and totally committed to environmental issues at every stage of the industrial cycle, from design to manufacturing. The ISO 14001 certification guarantees our long-term commitment.